

Features

- Epitaxial Planar Die Construction
- Complementary PNP Types Available (DDTA)
- Built-In Biasing Resistors, R1 = R2
- **Totally Lead-Free & Fully RoHS Compliant (Notes 1 & 2)**
- **Halogen and Antimony Free. "Green" Device (Note 3)**
- **Qualified to AEC-Q101 Standards for High Reliability**

Mechanical Data

- Case: SOT-523
- Case Material: Molded Plastic, "Green" Molding Compound
- UL Flammability Classification Rating 94V-0
- Moisture Sensitivity: Level 1 per J-STD-020
- Terminals: Finish – Matte Tin Plated Leads, Solderable per MIL-STD-202, Method 208@3
- Weight: 0.002 grams (Approximate)

Part Number	R1, R2 (NOM)
DDTC123EE	2.2kΩ
DDTC143EE	4.7kΩ
DDTC114EE	10kΩ
DDTC124EE	22kΩ
DDTC144EE	47kΩ
DDTC115EE	100kΩ



Top View

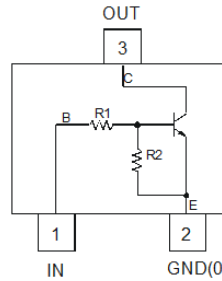

Device Schematic

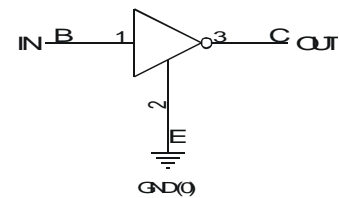

Equivalent Inverter Circuit

Ordering Information (Note 4)

Product	Compliance	Marking	Reel size (inches)	Tape width (mm)	Quantity per reel
DDTC123EE-7-F	AEC-Q101	N04	7	8	3,000
DDTC143EE-7-F	AEC-Q101	N08	7	8	3,000
DDTC114EE-7-F	AEC-Q101	N13	7	8	3,000
DDTC124EE-7-F	AEC-Q101	N17	7	8	3,000
DDTC144EE-7-F	AEC-Q101	N20	7	8	3,000
DDTC115EE-7-F	AEC-Q101	N24	7	8	3,000

- Notes:
1. No purposely added lead. Fully EU Directive 2002/95/EC (RoHS) & 2011/65/EU (RoHS 2) compliant.
 2. See http://www.diodes.com/quality/lead_free.html for more information about Diodes Incorporated's definitions of Halogen- and Antimony-free, "Green" and Lead-Free.
 3. Halogen- and Antimony-free "Green" products are defined as those which contain <900ppm bromine, <900ppm chlorine (<1500ppm total Br + Cl) and <1000ppm antimony compounds.
 4. For packaging details, go to our website at <http://www.diodes.com/products/packages.html>.

Marking Information

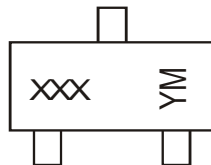

XXX = Product Type Marking Code, See Table Above
 YM = Date Code Marking
 Y = Year ex: D = 2016
 M = Month ex: 9 = September

Date Code Key

Year	2016	2017	2018	2019	2020	2021	2022	2023
Code	D	E	F	G	H	I	J	K

Month	Jan	Feb	Mar	Apr	May	Jun	Jul	Aug	Sep	Oct	Nov	Dec
Code	1	2	3	4	5	6	7	8	9	O	N	D

Absolute Maximum Ratings (@T_A = +25°C, unless otherwise specified.)

Characteristic		Symbol	Value	Unit
Supply Voltage <Pin: (3) to (2)>		V _{CC}	50	V
Input Voltage <Pin: (1) to (2)>	DDTC123EE	V _{IN}	-10 to +12	V
	DDTC143EE		-10 to +30	
	DDTC114EE		-10 to +40	
	DDTC124EE		-10 to +40	
	DDTC144EE		-10 to +40	
	DDTC115EE		-10 to +40	
Output Current	DDTC123EE	I _O	100	mA
	DDTC143EE		100	
	DDTC114EE		50	
	DDTC124EE		30	
	DDTC144EE		100	
	DDTC115EE		20	
Output Current	I _C (Max)	100	mA	

Thermal Characteristics (@T_A = +25°C, unless otherwise specified.)

Characteristic	Symbol	Value	Unit
Power Dissipation (Notes 5 & 6)	P _D	150	mW
Thermal Resistance, Junction to Ambient Air (Note 5)	R _{θJA}	833	°C/W
Operating and Storage Temperature Range	T _J , T _{STG}	-55 to +150	°C

Electrical Characteristics (@T_A = +25°C, unless otherwise specified.)

Characteristic		Symbol	Min	Typ	Max	Unit	Test Condition
Input Voltage		V _{I(off)} (Note 7)	0.5	1.1	—	V	V _{CC} = 5V, I _O = 100μA V _O = 0.3V, I _O = 20mA, DDTC123EE V _O = 0.3V, I _O = 20mA, DDTC143EE V _O = 0.3V, I _O = 10mA, DDTC114EE V _O = 0.3V, I _O = 5mA, DDTC124EE V _O = 0.3V, I _O = 2mA, DDTC144EE V _O = 0.3V, I _O = 1mA, DDTC115EE
		V _{I(on)} (Note 8)	—	1.9	3		
Output Voltage		V _{O(on)}	—	0.1	0.3	V	I _O /I _I = 10mA/0.5mA, DDTC123EE I _O /I _I = 10mA/0.5mA, DDTC143EE I _O /I _I = 10mA/0.5mA, DDTC114EE I _O /I _I = 10mA/0.5mA, DDTC124EE I _O /I _I = 10mA/0.5mA, DDTC144EE I _O /I _I = 5mA/0.25mA, DDTC115EE
Input Current	DDTC123EE DDTC143EE DDTC114EE DDTC124EE DDTC144EE DDTC115EE	I _I	—	—	3.8 1.8 0.88 0.36 0.18 0.15	mA	V _I = 5V
Output Current		I _{O(off)}	—	—	0.5	μA	V _{CC} = 50V, V _I = 0V
DC Current Gain	DDTC123EE DDTC143EE DDTC114EE DDTC124EE DDTC144EE DDTC115EE	G _I	20 20 30 56 68 82	—	—	—	V _O = 5V, I _O = 20mA V _O = 5V, I _O = 10mA V _O = 5V, I _O = 5mA V _O = 5V, I _O = 5mA V _O = 5V, I _O = 5mA V _O = 5V, I _O = 5mA
Input Resistor Tolerance		ΔR ₁	-30	—	+30	%	—
Resistance Ratio Tolerance		ΔR ₂ /R ₁	0.8	1	1.2	%	—
Gain-Bandwidth Product (Note 9)		f _T	—	250	—	MHz	V _{CE} = -10V, I _E = 5mA, f = 100MHz

- Notes:
- Mounted on FR4 PC Board with minimum recommended pad layout.
 - 150mW per element must not be exceeded.
 - Guarantees that the device will be switched OFF if the Input Voltage is less than 0.5V.
 - Guarantees that the device will be switched ON if the Input Voltage is more than 3V.
 - Transistor only.

Typical Electrical Characteristics

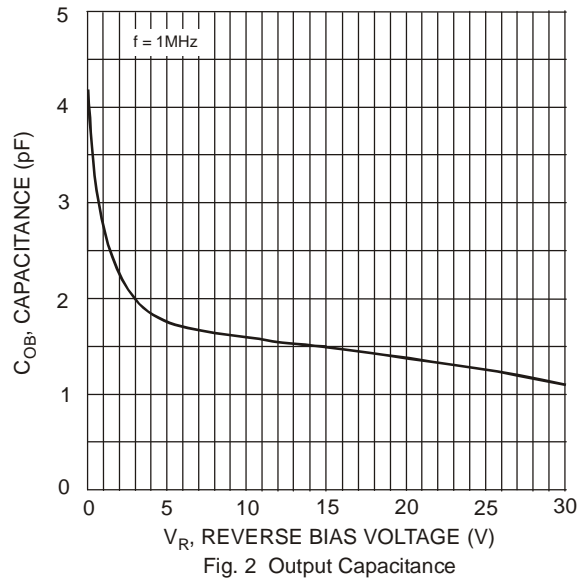
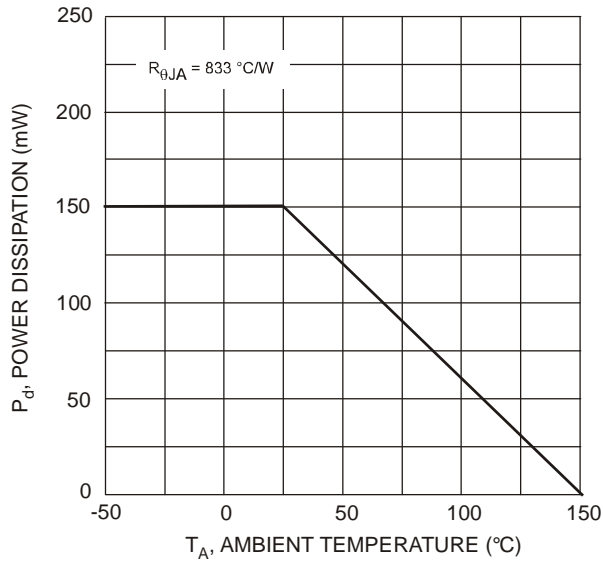

Typical Electrical Characteristics – DDTC123EE

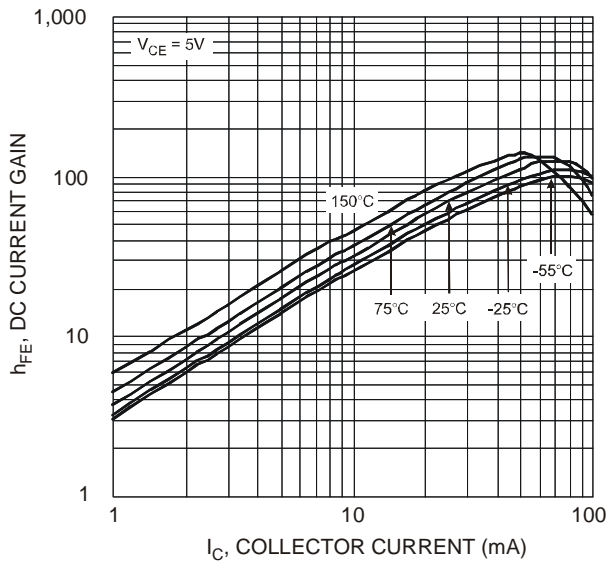

Fig. 3 Typical DC Current Gain vs. Collector Current

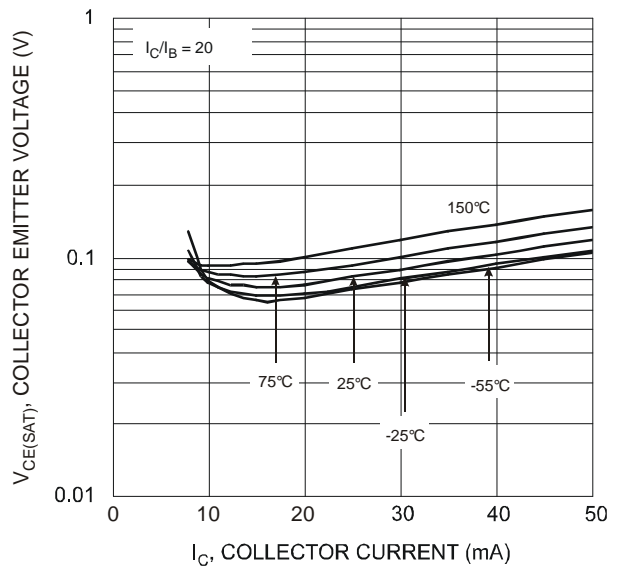

Fig. 4 $V_{CE(SAT)}$ vs. I_C

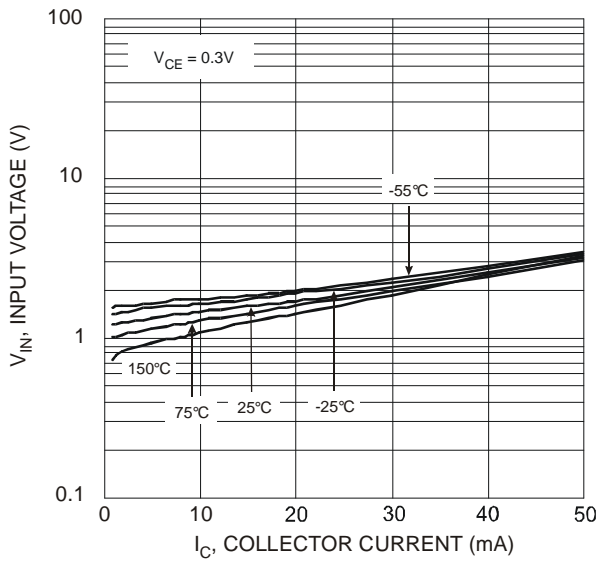

Fig. 5 Input Voltage vs. Collector Current

Typical Electrical Characteristics – DDTC143EE

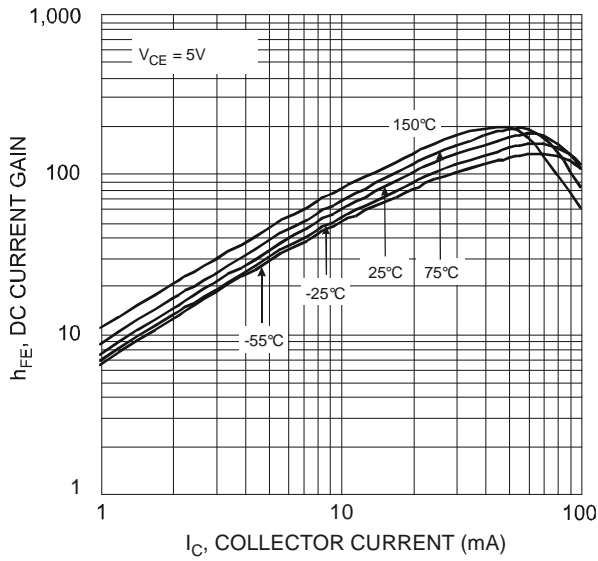

Fig. 6 Typical DC Current Gain vs. Collector Current

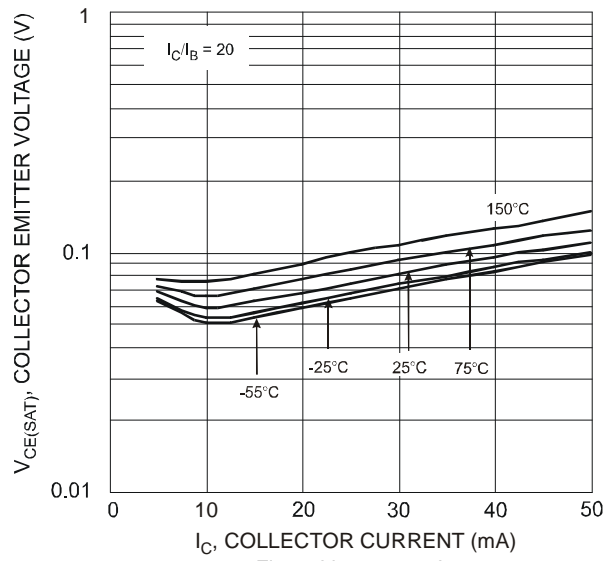

Fig. 7 $V_{CE(SAT)}$ vs. I_C

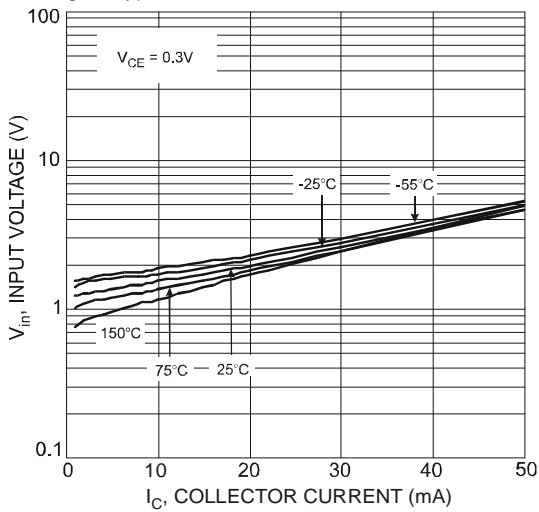

Fig. 8 Input Voltage vs. Collector Current

Typical Electrical Characteristics – DDTC114EE

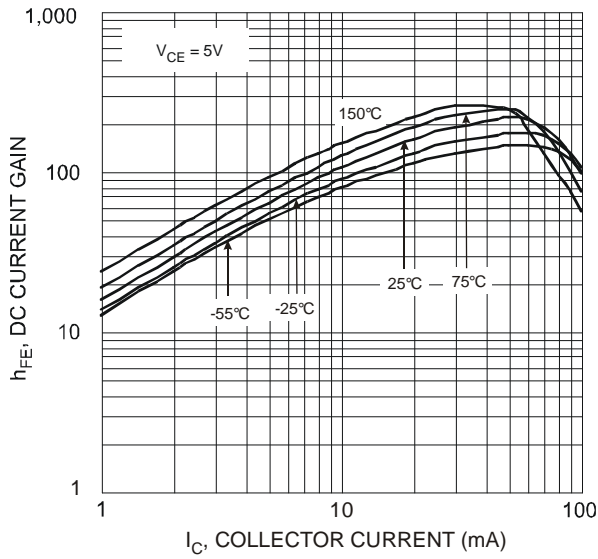

Fig. 9 Typical DC Current Gain vs. Collector Current

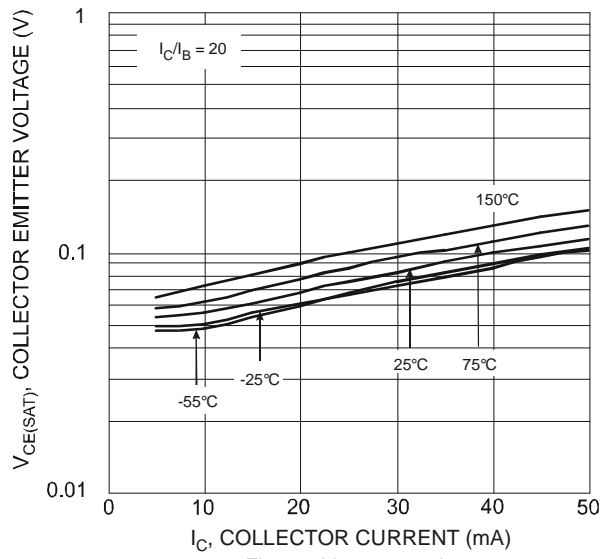

Fig. 10 $V_{CE(SAT)}$ vs. I_C

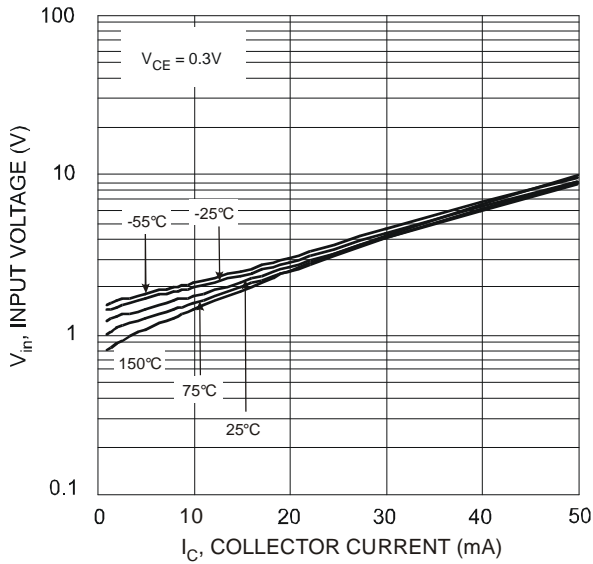

Fig. 11 Input Voltage vs. Collector Current

Typical Electrical Characteristics – DDTC124EE

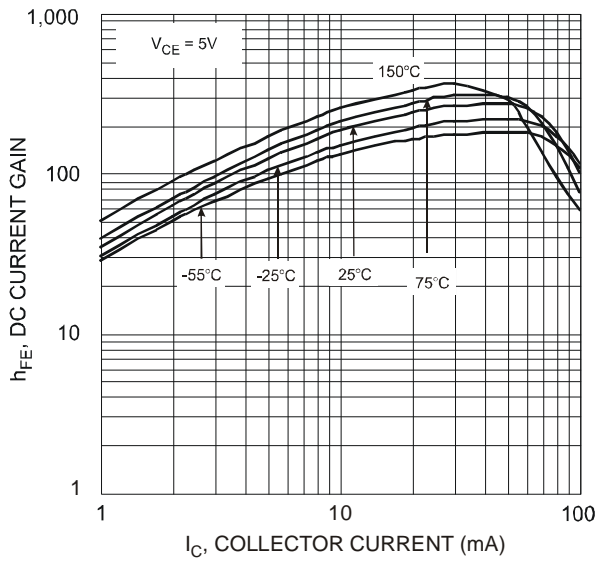

Fig. 12 Typical DC Current Gain vs. Collector Current

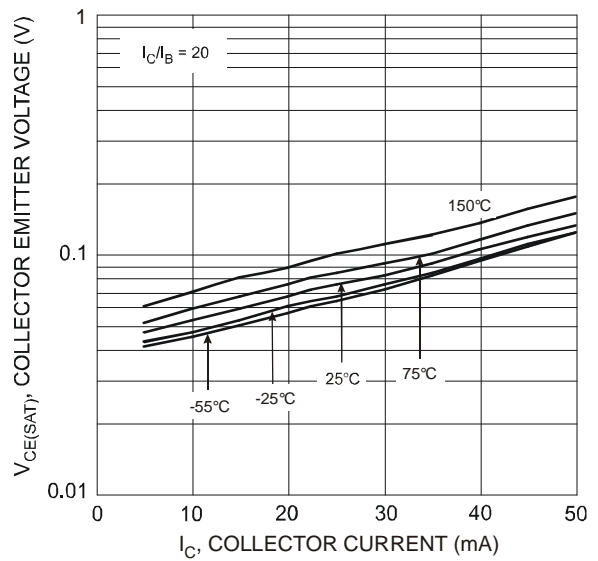

Fig. 13 $V_{CE(SAT)}$ vs. I_C

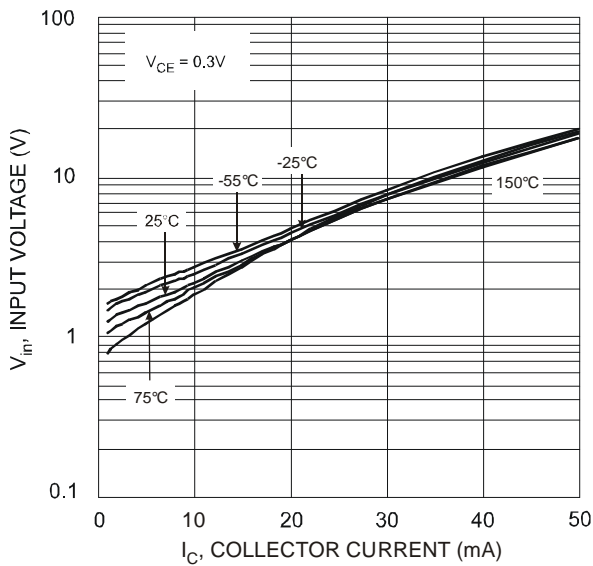

Fig. 14 Input Voltage vs. Collector Current

Typical Electrical Characteristics – DDTC144EE

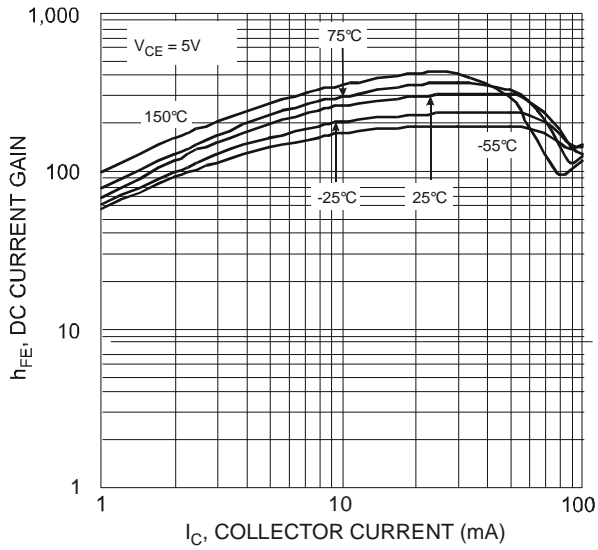

Fig. 15 Typical DC Current Gain vs. Collector Current

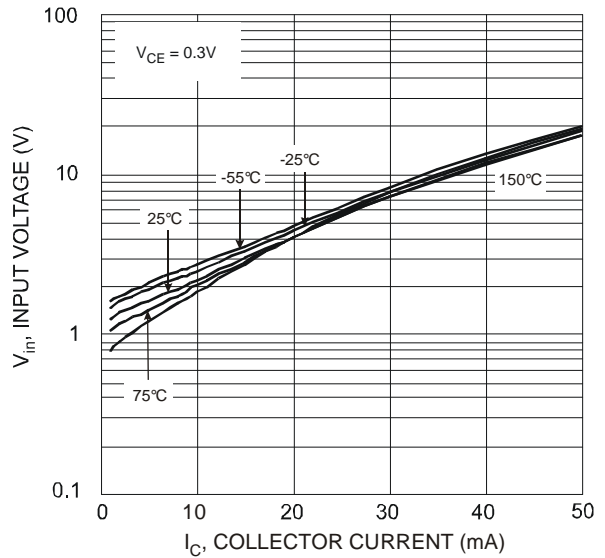

Fig. 16 Input Voltage vs. Collector Current

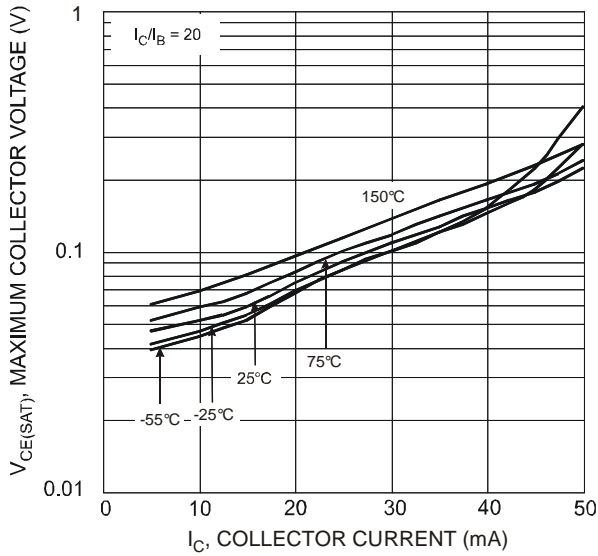
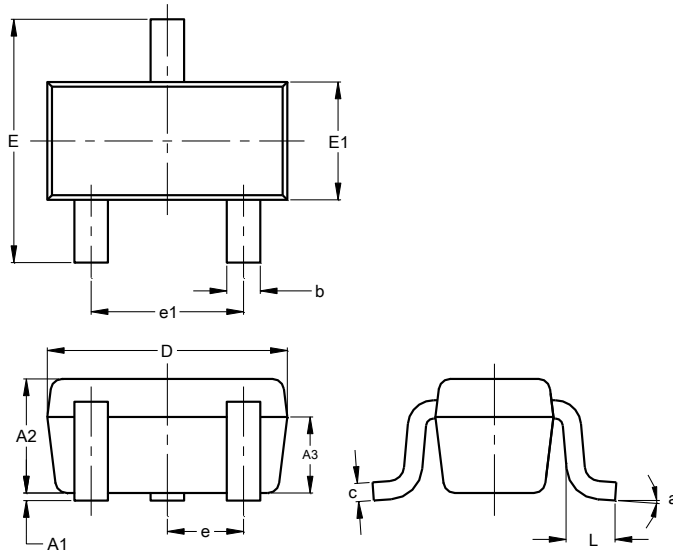

Fig. 17 $V_{CE(SAT)}$ vs. I_C

Package Outline Dimensions

Please see <http://www.diodes.com/package-outlines.html> for the latest version.



SOT523			
Dim	Min	Max	Typ
A	0.60	0.80	0.75
A1	0.00	0.10	0.05
A3	0.45	0.65	0.50
b	0.15	0.30	0.22
c	0.10	0.20	0.12
D	1.50	1.70	1.60
E	1.45	1.75	1.60
E1	0.75	0.85	0.80
e	0.50 BSC		
e1	0.90	1.10	1.00
L	0.20	0.40	0.33
a	0°	--	8°
All Dimensions in mm			

Suggested Pad Layout

Please see <http://www.diodes.com/package-outlines.html> for the latest version.

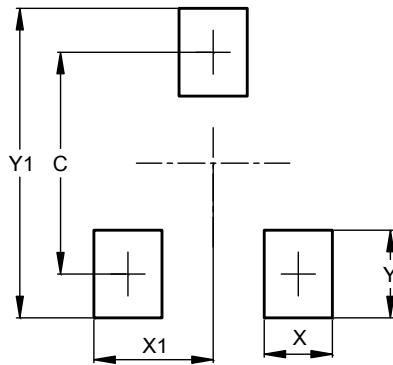

Dimensions	Value
C	1.29
X	0.40
X1	0.70
Y	0.51
Y1	1.80

IMPORTANT NOTICE

DIODES INCORPORATED MAKES NO WARRANTY OF ANY KIND, EXPRESS OR IMPLIED, WITH REGARDS TO THIS DOCUMENT, INCLUDING, BUT NOT LIMITED TO, THE IMPLIED WARRANTIES OF MERCHANTABILITY AND FITNESS FOR A PARTICULAR PURPOSE (AND THEIR EQUIVALENTS UNDER THE LAWS OF ANY JURISDICTION).

Diodes Incorporated and its subsidiaries reserve the right to make modifications, enhancements, improvements, corrections or other changes without further notice to this document and any product described herein. Diodes Incorporated does not assume any liability arising out of the application or use of this document or any product described herein; neither does Diodes Incorporated convey any license under its patent or trademark rights, nor the rights of others. Any Customer or user of this document or products described herein in such applications shall assume all risks of such use and will agree to hold Diodes Incorporated and all the companies whose products are represented on Diodes Incorporated website, harmless against all damages.

Diodes Incorporated does not warrant or accept any liability whatsoever in respect of any products purchased through unauthorized sales channel. Should Customers purchase or use Diodes Incorporated products for any unintended or unauthorized application, Customers shall indemnify and hold Diodes Incorporated and its representatives harmless against all claims, damages, expenses, and attorney fees arising out of, directly or indirectly, any claim of personal injury or death associated with such unintended or unauthorized application.

Products described herein may be covered by one or more United States, international or foreign patents pending. Product names and markings noted herein may also be covered by one or more United States, international or foreign trademarks.

This document is written in English but may be translated into multiple languages for reference. Only the English version of this document is the final and determinative format released by Diodes Incorporated.

LIFE SUPPORT

Diodes Incorporated products are specifically not authorized for use as critical components in life support devices or systems without the express written approval of the Chief Executive Officer of Diodes Incorporated. As used herein:

A. Life support devices or systems are devices or systems which:

1. are intended to implant into the body, or
2. support or sustain life and whose failure to perform when properly used in accordance with instructions for use provided in the labeling can be reasonably expected to result in significant injury to the user.

B. A critical component is any component in a life support device or system whose failure to perform can be reasonably expected to cause the failure of the life support device or to affect its safety or effectiveness.

Customers represent that they have all necessary expertise in the safety and regulatory ramifications of their life support devices or systems, and acknowledge and agree that they are solely responsible for all legal, regulatory and safety-related requirements concerning their products and any use of Diodes Incorporated products in such safety-critical, life support devices or systems, notwithstanding any devices- or systems-related information or support that may be provided by Diodes Incorporated. Further, Customers must fully indemnify Diodes Incorporated and its representatives against any damages arising out of the use of Diodes Incorporated products in such safety-critical, life support devices or systems.

Copyright © 2016, Diodes Incorporated

www.diodes.com